

SRS Rating Certificate : 2784

Imprimé le 21.04.2026
Valide jusqu'au 31.03.2027



Nom Joda

N° voile SUI 1851
Type bateau J/70
Mesuré par Série SRS
Immatriculation/CIN GE 23484
Assurance RC Helvetia
Propriétaire CERN Yachting Club
Email club-yachting-committee@cern.ch
Téléphone(s) 0041798167890 / 0041798167890
Région ACVL
Club/Licence YCC / 44855

SRS 0.987

SRS solo 1.026
SRS duo 1.016
SRS High 1.100
CCR 313

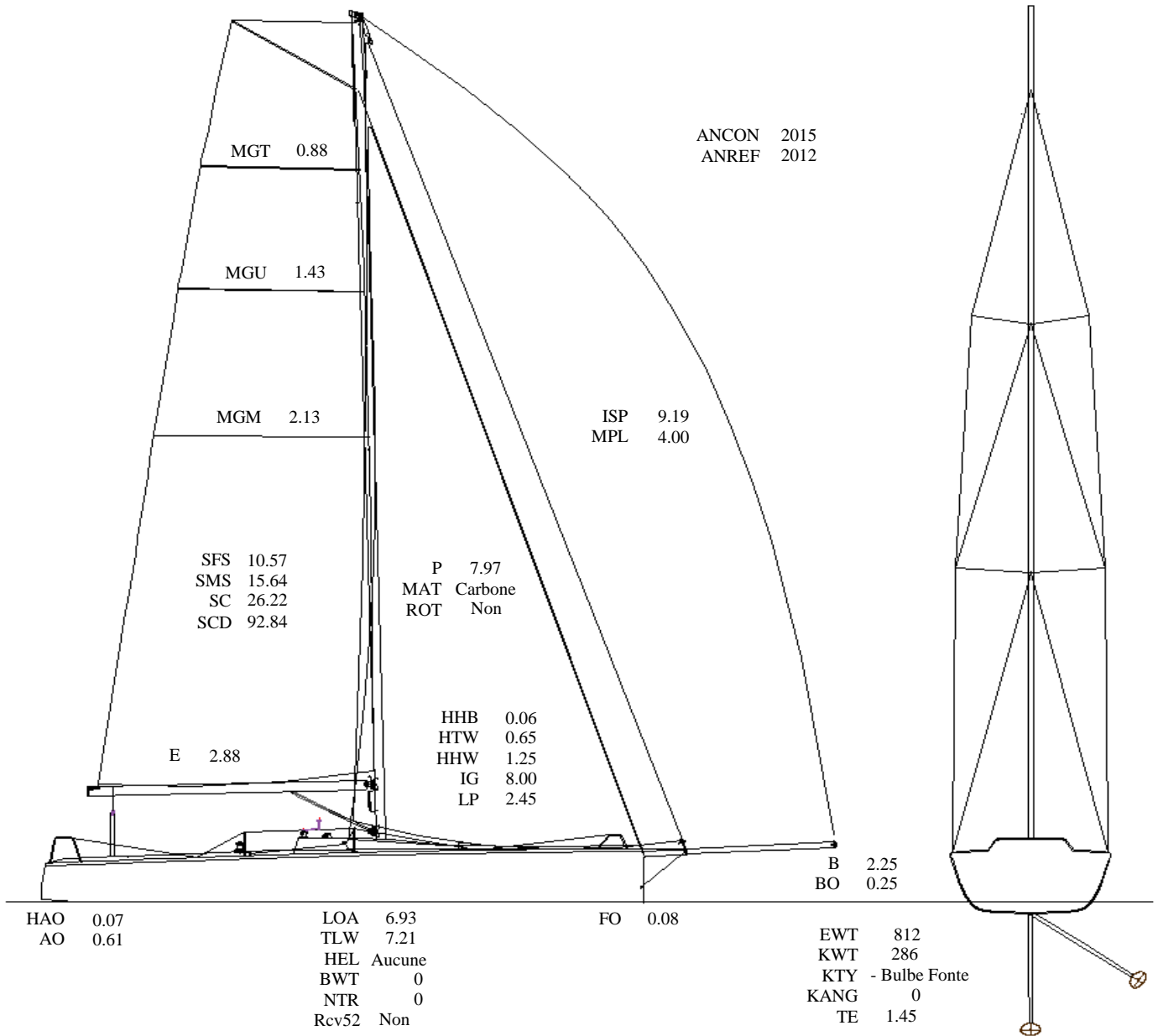

Remarks:

Classes:	A	B	C	D	E	F	G
System	TCF4	TR6	LA	R2	B	-	CR